

Superior Pourable Chocking System



Belzona 7111 is a pourable chocking, backing and levelling system that has been developed to withstand the harsh physical and thermal shock of marine and industrial environments.

It is ideal for pouring foundations, shimming or chocking heavy propulsion systems and other industrial large equipment where alignment and anchorage are essential. Its load bearing capability is demonstrated by its high compressive strength. Unlike other liquid-applied chocking systems, it provides longer storage time without the risk of particle setting.

Belzona 7111 flows easily into the application area conforming to irregularities and filling voids to create the perfect chock.



TECHNICAL DATA	Mixing ratio (base:solidifier)	14.5 : 1 by weight* *Refer to IFU for thickness greater than 38 mm (1 1/2 inch)		
	Working life	30 minutes at 25°C (77°F)		
	Shelf life	4 years		
	Compressive Strength	213.1 MPa (30,908 psi) 16 hour cure at 70°C (158°F)		
	Hardness	Shore D: 89.5	Barcol: 40	
	Adhesion (pull-off)	Mild steel: 26.8 MPa (3,880 psi)	Concrete: 6.8 MPa (980 psi)*	
	Shear Strength	45.4 MPa (6,590 psi) at 20°C (68°F) cure and test		
	Volume Capacity	4360 cm ³ (266 in ³) / 6.95 kg at 12-100 mm (0.5-4 in)		
	Tensile Strength	44.2 MPa (6,410 psi) at 20°C (68°F) cure and test		
Adhesion (tensile shear)	Mild steel: 24.6 MPa (3,570 psi)	Stainless steel: 20.0 MPa (2,900 psi)		

CURE TIMES	Temperature	15°C (60°F)	20°C (68°F)	30°C (86°F)
	Cure Times	48 hours	24 hours	12 hours

*Please consult the Product Specification Sheet (PSS) and Instructions for Use (IFU) for the latest technical data.



**EASILY
POURABLE**



**PRESSURE
RESISTANCE**



**IMPACT
RESISTANCE**



**VIBRATION
RESISTANT**



**NO HOT
WORK**



**DAMPENS
MACHINE NOISE**

Key Benefits:

- Provides precise equipment alignment
This self-levelling material can be used to create a perfectly even base for machinery or equipment foundations.
- Prevents loosening of threaded bolts
By using Belzona 7111, the risk of slack bolts is dramatically reduced.
- Reduced installation time
Belzona 7111 is a pourable chocking solution and avoids the needs to machine foundations before application, saving time and money.

Application:



Before

After

Typical Chocking Application:

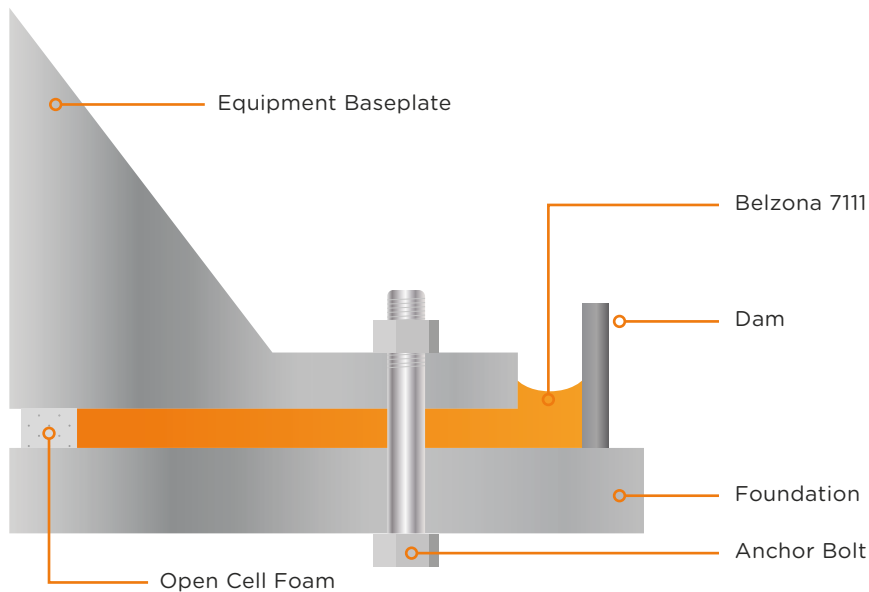

Application Areas:

- Bearing blocks
- Blowers
- Crane rails
- Compressors
- Engines
- Generators
- Lathes
- Propulsion and auxiliary machinery
- Pulverisers
- Pumps
- Reduction gears
- Steam and gas turbines
- Stern tube and strut bearings

For more information, please contact your local Belzona representative:

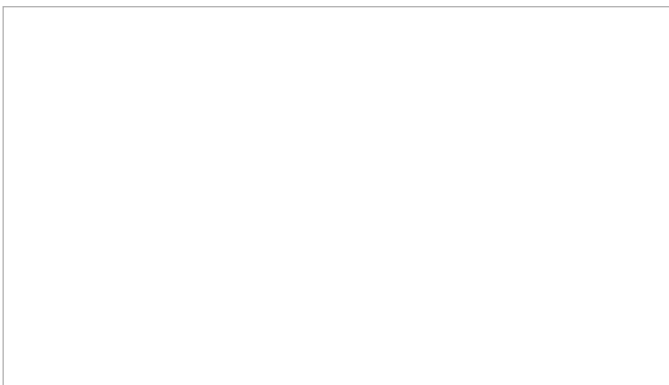

QUALITY PRODUCTS - TECHNICAL SUPPORT

Belzona products are manufactured under an ISO 9001 Registered Quality Management System.

Belzona has a global distribution network of over 140 Distributors operating in 120 countries. Local support is provided by a trained Technical Consultant who will diagnose the problem, recommend the solution and provide 24-hour, on-site application supervision and advice.